



D



S



S

1 INFORMATIONS GÉNÉRALES

- **Matériau:** Laiton 5mm/6mm
- **Poids:** 120g **S** /200g **D** /280g **T**
- **Entraxe vis:** 60mm
- **Fixation:** À vis ou sans vis
- **Montage:** 3 minutes vis / 1 minute aimant
- **Boîtes d'encastrement compatibles:**
LEG 080031 **S**
LEG 080032 **D**
LEG 080033 **T**



2 FINITIONS



Nickel
Brossé
478



Laiton
Brossé
479



Canon
de fusil
474

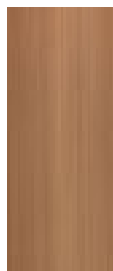

Vieux
Bronze
477

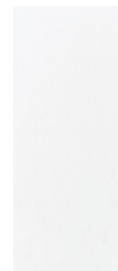

Blanc
Mat
471



Noir
Mat
472

3 DESIGNS DISPONIBLE

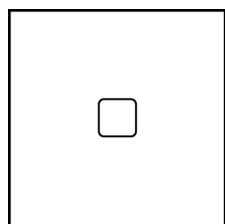

E0 - PLAN

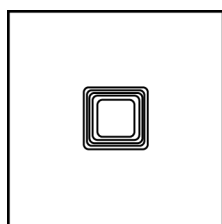

E1 -
VOLUME

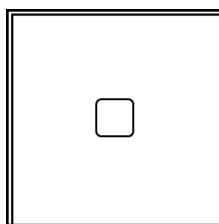

E2 - ANGLE

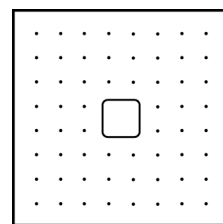

E4 - POINT

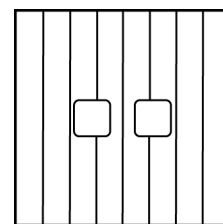

E5 - LIGNE

4 FORMATS

Dimensions en mm

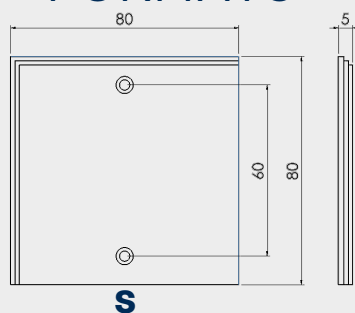

S

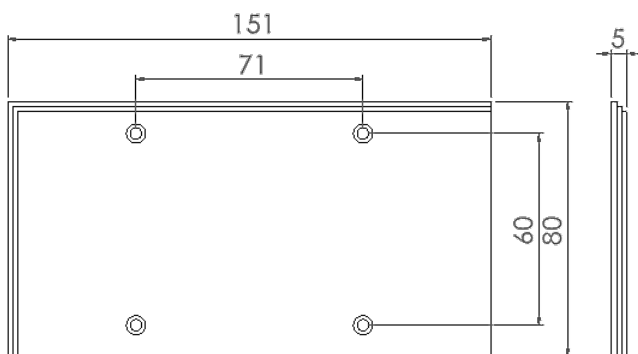

D

Sauf E5 pas de double verticale

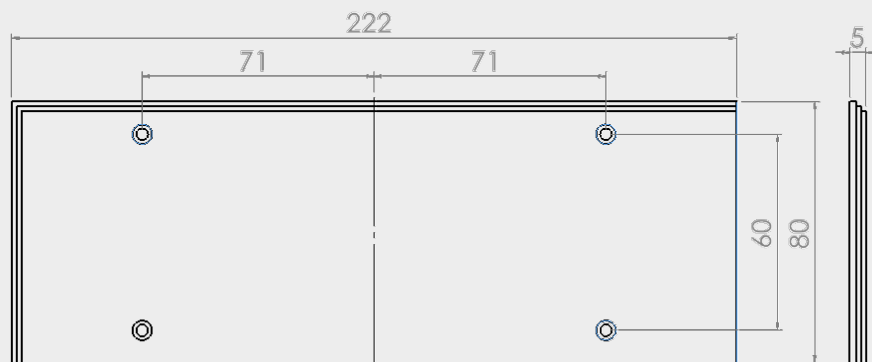
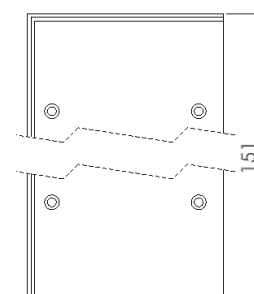





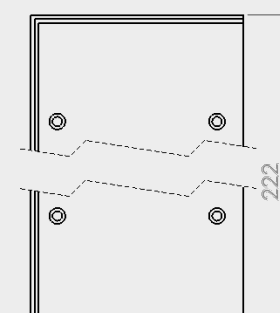



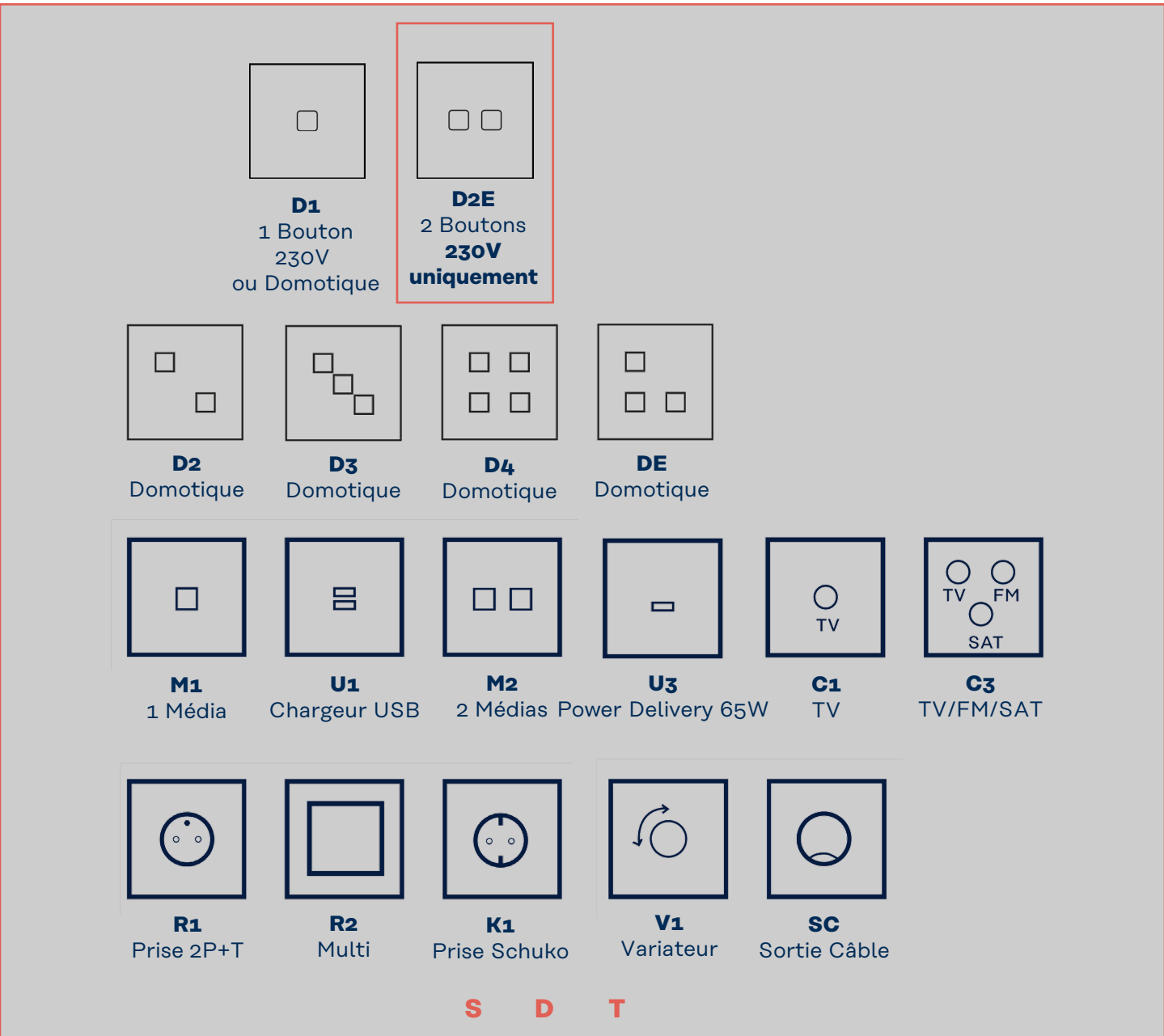

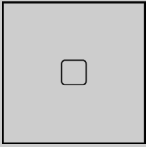
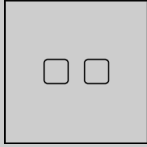
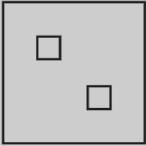
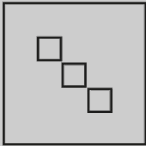
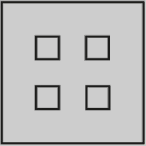
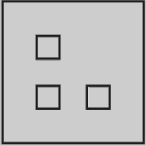
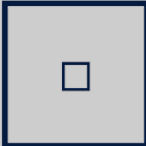
T

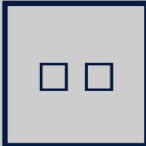
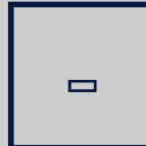
Sauf E5 pas de triple verticale



4 FONCTIONS DISPONIBLES

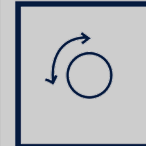

					
D1 1 Bouton 230V ou Domotique	D2E 2 Boutons 230V uniquement				
					
D2 Domotique	D3 Domotique	D4 Domotique	DE Domotique		
					
M1 1 Média	U1 Chargeur USB	M2 2 Médias	U3 Power Delivery 65W	C1 TV	C3 TV/FM/SAT
					
R1 Prise 2P+T	R2 Multi	K1 Prise Schuko	V1 Variateur	SC Sortie Câble	
S D T					

LEXIQUE

Bouton: va-et-vient 230V / poussoir 230V / poussoir TBTS domotique

Média: RJ45 / HDMI / USB DATA / HP

Multi: détecteur / lecteur badge / prises internationales

5 MONTAGE

FAÇADE À AIMANTS

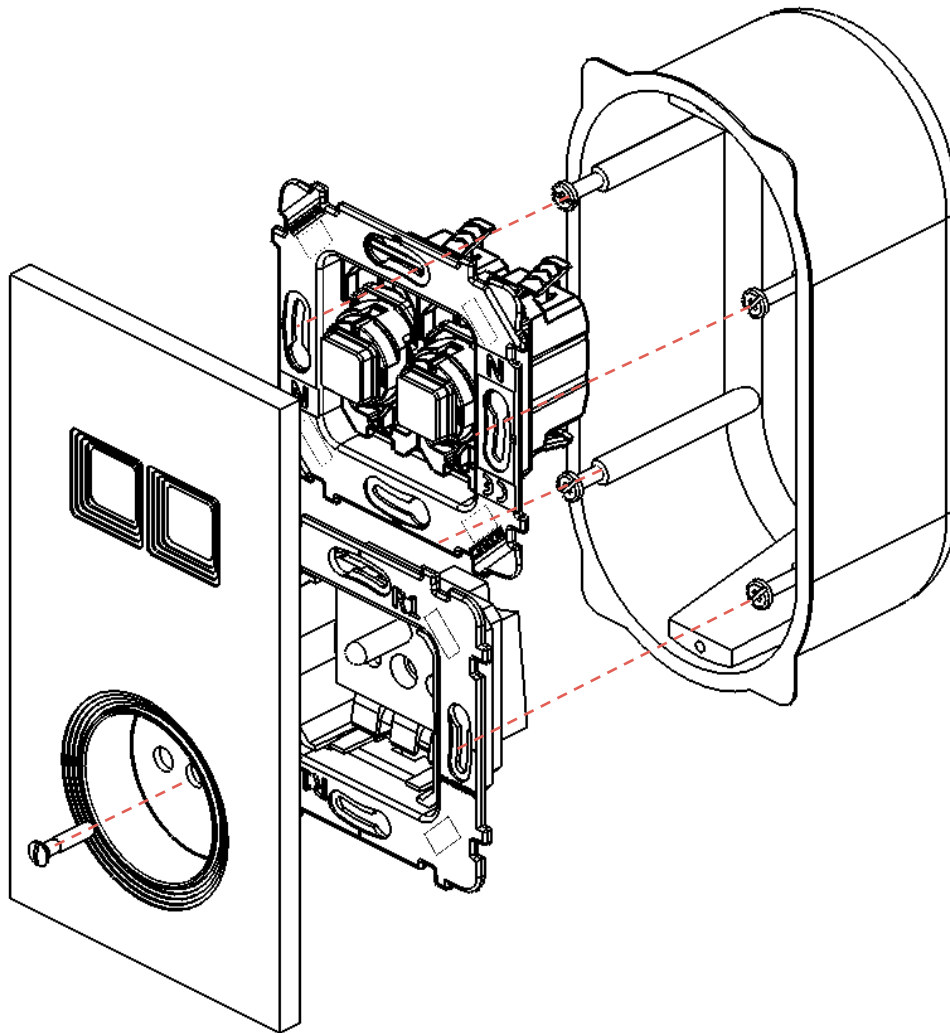

1. Réaliser le câblage du mécanisme selon le schéma correspondant.
2. Plaquer et visser le ou les mécanismes dans le boîtier d'encastrement standard.
3. Veillez à un positionnement vertical correct.
4. Approchez la façade du mécanisme et laissez le pouvoir de l'aimantation agir.



6 ENTRETIEN

L'entretien et le nettoyage des façades doit être réalisé à l'aide d'un chiffon doux. On pourra utiliser un chiffon dit microfibre à sec ou légèrement humidifié d'eau claire.

L'usage de lingette imbibées est possible, mais le produit devra contenir moins de 5% d'alcool ionique.



Exclure absolument les produits suivants:

Les produits javélisés ou chlorés.

Les poudres à récurer ou rénovateurs (composants abrasifs).

Les diluants et essences diverses.

Les produits spéciaux pour métaux.



Veillez absolument aux bonnes pratiques suivantes:

Ne pas poser de ruban adhésif même de façon temporaire.

Ne pas projetez de peintures ou de vernis.

Ne pas laissez les façades proches d'émanations de produits décapants.

Lors de travaux, démonter les façades et les stocker dans un endroit sec, tempéré entre -5°C et +35°C.

